

Approval body for construction products
and types of construction

Bautechnisches Prüfamt

An institution established by the Federal and
Laender Governments



European Technical Assessment

ETA-12/0042
of 8 June 2018

English translation prepared by DIBt - Original version in German language

General Part

Technical Assessment Body issuing the
European Technical Assessment:

Deutsches Institut für Bautechnik

Trade name of the construction product

SHARK PRO

Product family
to which the construction product belongs

Plastic anchor for multiple use in concrete and masonry
for non-structural applications

Manufacturer

Adolf Würth GmbH & Co. KG
Reinhold-Würth-Straße 12-17
74653 Künzelsau
DEUTSCHLAND

Manufacturing plant

manufacturing plant 2

This European Technical Assessment
contains

35 pages including 3 annexes which form an integral part
of this assessment

This European Technical Assessment is
issued in accordance with Regulation (EU)
No 305/2011, on the basis of

ETAG 020, edition March 2012,
used as EAD according to Article 66 Paragraph 3 of
Regulation (EU) No 305/2011

The European Technical Assessment is issued by the Technical Assessment Body in its official language. Translations of this European Technical Assessment in other languages shall fully correspond to the original issued document and shall be identified as such.

Communication of this European Technical Assessment, including transmission by electronic means, shall be in full. However, partial reproduction may only be made with the written consent of the issuing Technical Assessment Body. Any partial reproduction shall be identified as such.

This European Technical Assessment may be withdrawn by the issuing Technical Assessment Body, in particular pursuant to information by the Commission in accordance with Article 25(3) of Regulation (EU) No 305/2011.

Specific Part

1 Technical description of the product

The Würth plastic anchor SHARK PRO in the sizes SHARK PRO 6, SHARK PRO 8, SHARK PRO 10, SHARK PRO 12 and SHARK PRO 14 is a plastic anchor consisting of a plastic sleeve made of polyamide and an accompanying specific screw of galvanised steel or stainless steel.

The plastic sleeve is expanded by screwing in the specific screw which presses the sleeve against the wall of the drilled hole.

The product description is given in Annex A.

2 Specification of the intended use in accordance with the applicable European Assessment Document

The performances given in Section 3 are only valid if the anchor is used in compliance with the specifications and conditions given in Annex B.

The verifications and assessment methods on which this European Technical Assessment is based lead to the assumption of a working life of the anchors of at least 50 years. The indications given on the working life cannot be interpreted as a guarantee given by the producer, but are to be regarded only as a means for choosing the right products in relation to the expected economically reasonable working life of the works.

3 Performance of the product and references to the methods used for its assessment

3.1 Mechanical resistance and stability (BWR 1)

The essential characteristics regarding mechanical resistance and stability are included under the Basic Works Requirement Safety in use.

3.2 Safety in case of fire (BWR 2)

Essential characteristic	Performance
Reaction to fire	Anchorage satisfy requirements for Class A 1
Resistance to fire	See Annex C 3

3.3 Safety and accessibility (BWR 4)

Essential characteristic	Performance
Characteristic resistance for tension and shear loads	See Annexes C 1, C 2, C 7 – C 21
Characteristic resistance for bending moments	See Annex C 1, C 2
Displacements under shear and tension loads	See Annex C 3
Anchor distances and dimensions of members	See Annex B 3, B 4

English translation prepared by DIBt

4 Assessment and verification of constancy of performance (AVCP) system applied, with reference to its legal base

In accordance with guideline for European technical approval ETAG 020, March 2012 used as European Assessment Document (EAD) according to Article 66 Paragraph 3 of Regulation (EU) No 305/2011 the applicable European legal act is: 97/463/EC.

The system to be applied is: 2+

5 Technical details necessary for the implementation of the AVCP system, as provided for in the applicable European Assessment Document

Technical details necessary for the implementation of the AVCP system are laid down in the control plan deposited at Deutsches Institut für Bautechnik.

Issued in Berlin on 8 June 2018 by Deutsches Institut für Bautechnik

BD Dipl.-Ing. Andreas Kummerow
Head of Department

beglaubigt:
Ziegler

Plastic anchor SHARK PRO – pre-positioned installation

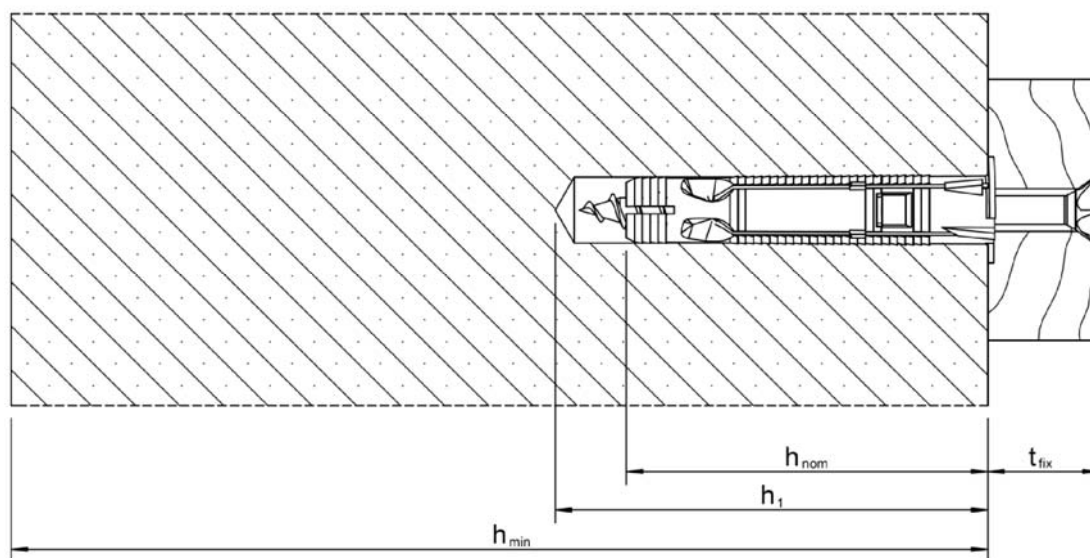
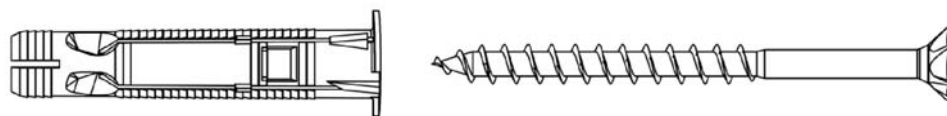

Intended use

Plastic anchor for **pre-positioned anchorages** for multiple use in cracked or non-cracked concrete and masonry.

Legend:

- h_{nom} : Overall plastic anchor embedment depth in the base material
- h_1 : Depth of drilled hole to deepest point
- h_{min} : minimum thickness of member
- t_{fix} : Thickness of fixture

SHARK PRO

Product description

Product and installed condition pre-positioned installation

Annex A 1

Plastic anchor SHARK PRO 12 – in-place installation

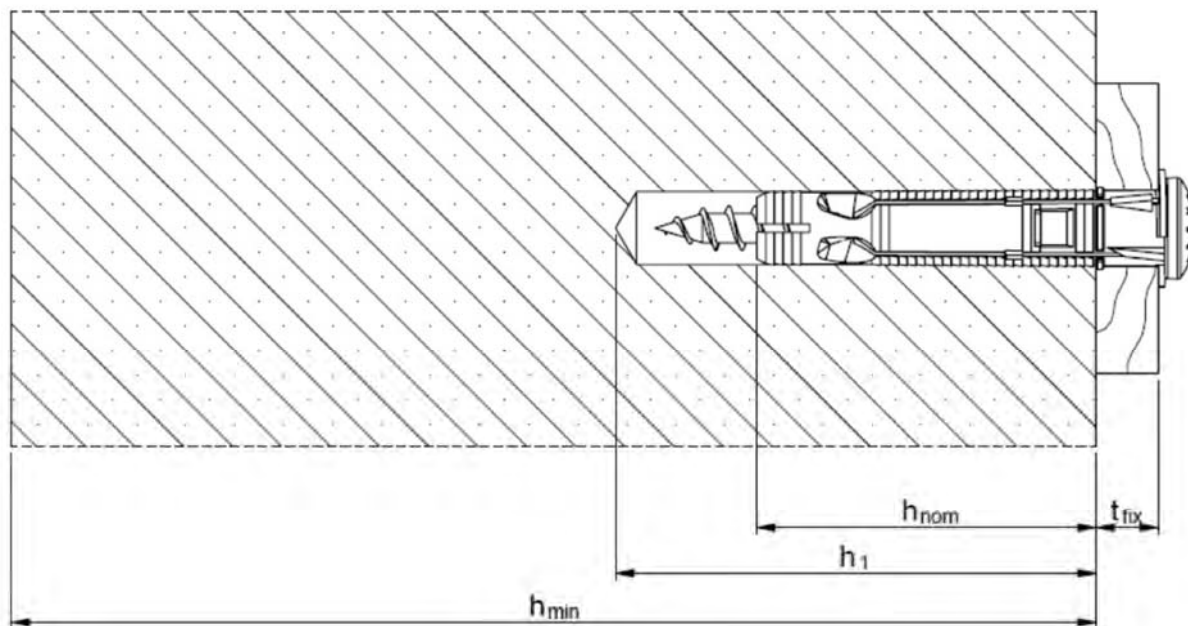

Intended use

Plastic anchor SHARK PRO 12 for **in-place installation** for multiple use in cracked or non-cracked concrete and masonry.

Legend:

- h_{nom} : Overall plastic anchor embedment depth in the base material
- h_1 : Depth of drilled hole to deepest point
- h_{min} : Thickness of member
- t_{fix} : Thickness of fixture

SHARK PRO

Product description

Product and installed condition in-place installation – SHARK PRO 12

Annex A 2

Plastic sleeve SHARK PRO

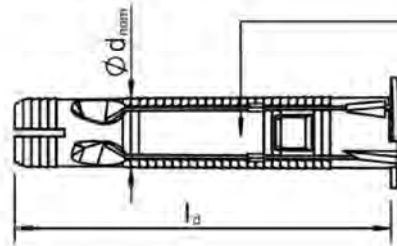

Marking:
Identifying mark of the producer
Anchor type
Diameter
eg. SHARK PRO 10

Special screw ASSY-D

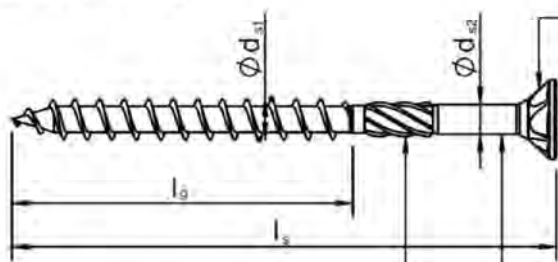

Cutter ribs or milling pockets
optional

Shank cutter and
shank optional

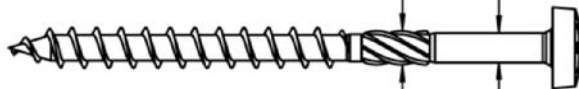

Shank cutter and
shank optional

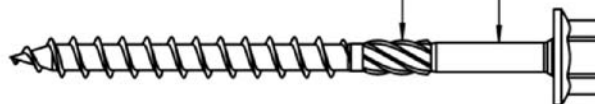

Additional shank
optional

Cutter ribs or milling pockets
optional



Marking:
eg. ASSY-D,*
ASSY-D,*A4
DxLLL

SHARK PRO

Product description
Anchor types / specific screw – marking

Annex A 3

Table A 1.1: Anchor Dimensions

Anchor type		SHARK PRO					
		6	8	10	12	14	
Overall plastic anchor embedment depth ¹⁾	$h_{nom} \geq$ [mm]	34	45	55	57	65	75
Plastic sleeve							
Plastic sleeve diameter	$\varnothing d_{nom} =$ [mm]	6	8	10	12	14	
Length of plastic sleeve	l_d [mm]	35	46	56	66	76	
Flat collar diameter	$\varnothing d_k =$ [mm]	10	13	16	19.5	22.5	
Thickness of flat collar	$l_k \geq$ [mm]	0.5	0.7	0.8	1	1.2	
Special screw ASSY-D							
Screw diameter	$d_{s1} =$ [mm]	5	6	8	10	12	
Screw diameter	$d_{s2} =$ [mm]	3.7	4.4	5.8	7.3	8.3	
Length of screw	$l_s =$ [mm]	$t_{fix} + 40$	$t_{fix} + 50$	$t_{fix} + 60$	$t_{fix} + 70$	$t_{fix} + 80$	
Length of thread	$l_g \geq$ [mm]	40	50	60	76	80	
Thickness of fixture for screw $l_s = 50$ mm	t_{fix} [mm]	1-10	-	-	-	-	
Thickness of fixture for screw $l_s = 60$ mm	t_{fix} [mm]	1-20	1-10	-	-	-	
Thickness of fixture for screw $l_s = 70$ mm	t_{fix} [mm]	10-30	1-20	1-10	-	-	
Thickness of fixture for screw $l_s = 80$ mm	t_{fix} [mm]	20-40	10-30	1-20	1-10 ²⁾	-	
Thickness of fixture for screw $l_s = 90$ mm	t_{fix} [mm]	30-50	20-40	10-30	1-20	1-10	
Thickness of fixture for screw $l_s = 100$ mm	t_{fix} [mm]	40-60	30-50	20-40	1-30	1-20	
Thickness of fixture for screw $l_s = 110$ mm	t_{fix} [mm]	50-70	40-60	30-50	10-40	1-30	
Thickness of fixture for screw $l_s = 120$ mm	t_{fix} [mm]	60-80	50-70	40-60	20-50	10-40	
Thickness of fixture for screw $l_s = 130$ mm	t_{fix} [mm]	70-90	60-80	50-70	30-60	20-50	
Thickness of fixture for screw $l_s = 140$ mm	t_{fix} [mm]	80-100	70-90	60-80	40-70	30-60	
Thickness of fixture for screw $l_s = 150$ mm	t_{fix} [mm]	90-110	80-100	70-90	50-80	40-70	
Thickness of fixture for screw $l_s = 160$ mm	t_{fix} [mm]	100-120	90-110	80-100	60-90	50-80	
Thickness of fixture for screw $l_s = 170$ mm	t_{fix} [mm]	110-130	100-120	90-110	70-100	60-90	
Thickness of fixture for screw $l_s = 200$ mm	t_{fix} [mm]	140-160	130-150	120-140	100-130	90-120	
Thickness of fixture for screw $l_s = 220$ mm	t_{fix} [mm]	160-180	150-170	140-160	120-150	110-140	
Thickness of fixture for screw $l_s = 240$ mm	t_{fix} [mm]	180-200	170-190	160-180	140-180	130-160	

¹⁾ See Annex A1, A2

²⁾ For SHARK PRO 12

SHARK PRO

Product description
Anchor dimensions

Annex A 4

Table A 2.1: Materials

Designation	Material
Plastic sleeve	Polyamide, colour anthrazit or brown
Special screw	Carbon steel according to EN ISO 4042:1999, galvanised
	Stainless steel, 1.4401, 1.4571 or 1.4578

SHARK PRO

Product description
Materials

Annex A 5

Specifications of intended use

Anchorage subject to:

- Static and quasi-static loads:
- Multiple fixing of non-structural applications

Base materials:

- Reinforced or unreinforced normal weight concrete with strength classes $\geq C12/15$ (use category a), according to EN 206-1:2000, Annex C 1, C 2, Precast prestressed hollow core slabs according to Annex C 21.
- Solid brick masonry (use category b), according to Annex C 7, C 8, C 11 - C 12, C 16 - C 19.
Note: The characteristic resistance is also valid for larger brick sizes and larger compressive strength of the masonry unit.
- Hollow brick masonry (use category c), according to Annex C 9, C 10, C 13 - C 15.
- Autoclaved aerated concrete (use category d), according to Annex C 20
- Mortar strength class of the masonry $\geq M2,5$ at minimum according to EN 998-2:2010.
- For other base materials of the use categories a, b, c and d the characteristic resistance of the anchor may be determined by job site tests according to ETAG 020, Annex B Edition March 2012.

Temperature Range:

- Temperature Range a): 24 °C bis + 40 °C (max. long temperature +24 °C und max. short temperature + 40 °C)

Use conditions (Environmental conditions):

- Structures subject to dry internal conditions (zinc coated steel, stainless steel).
- For in-place installation the specific screw made of galvanized steel may also be used in structures subject to external atmospheric exposure, if the area of the head of the screw is protected against moisture and driving rain after mounting of the fixing unit in this way, that intrusion of moisture into the anchor shaft is prevented. Therefore there shall be an external cladding or a ventilated rainscreen mounted in front of the head of the screw and the head of the screw itself shall be coated with a soft plastic, permanently elastic bitumen-oil-combination coating (e. g. undercoating or body cavity protection for cars).
- Structures subject to external atmospheric exposure (including industrial and marine environment) and to permanently damp internal condition, if no particular aggressive conditions exist (stainless steel).
- Note: Particular aggressive conditions are e.g. permanent, alternating immersion in seawater or the splash zone of seawater, chloride atmosphere of indoor swimming pools or atmosphere with extreme chemical pollution (e.g. in desulphurization plants or road tunnels where de-icing materials are used).

Design:

- The anchorages are designed in accordance with the ETAG 020, Annex C Edition March 2012 under the responsibility of an engineer experienced in anchorages and masonry work.
- Verifiable calculation notes and drawings shall be prepared taking account of the loads to be anchored, the nature and strength of the base materials and the dimensions of the anchorage members as well as of the relevant tolerances. The position of the anchor is indicated on the design drawings.
- Fasteners are only to be used for multiple use for non-structural application, according to ETAG 020 Edition March 2012.

Installation:

- Hole drilling by the drill modes according to Annex C 7 - C 21
- Anchor installation carried out by appropriately qualified personnel and under the supervision of the person responsible for technical matters of the site
- Installation temperature ≥ -20 °C
- Exposure to UV due to solar radiation of the anchor not protected ≤ 6 weeks

SHARK PRO

Intended use
Specifications

Annex B 1

Table B 1.1: Installation parameters in concrete

Anchor type		SHARK PRO				
		6	8	10	12	14
Drill hole diameter	$d_0 =$ [mm]	6	8	10	12	14
Overall plastic anchor embedment depth in the base material ¹⁾	$h_{nom} \geq$ [mm]	34	45	55	57 65	75
Cutting diameter of drill bit	$d_{cut} \leq$ [mm]	6.4	8.45	10.45	12.45	14.45
Depth of drilled hole to deepest point ¹⁾	$h_1 \geq$ [mm]	$l_s + 5 \text{ mm} - t_{fix}$				
Drill method	[-]	Hammer drilling				
Diameter of clearance hole in the fixture Pre-positioned installation	$d_f \leq$ [mm]	5.5	6.5	8.5	10.5	12.5
Diameter of clearance hole in the fixture In-place installation	$d_f \leq$ [mm]	-	-	-	14.5	-

¹⁾ See Annex A1, A2

SHARK PRO

Intended use
Installation parameters for use in concrete

Annex B 2

Table B 2.1: Minimum thickness of member, edge distance and spacing in concrete

- SHARK PRO 6:** Fixing points with a spacing $a \leq 35$ mm are considered as a group with a max. characteristic resistance $N_{Rk,p}$ acc. to Table C 1.1, C 2.1. For $a > 35$ mm, the anchors are considered as single anchors, each with a characteristic resistance $N_{Rk,p}$ acc. to Table C 1.1, C 2.1.
- SHARK PRO 8:** Fixing points with a spacing $a \leq 40$ mm are considered as a group with a max. characteristic resistance $N_{Rk,p}$ acc. to Table C 1.1, C 2.1. For $a > 40$ mm, the anchors are considered as single anchors, each with a characteristic resistance $N_{Rk,p}$ acc. to Table C 1.1, C 2.1.
- SHARK PRO 10:** Fixing points with a spacing $a \leq 80$ mm are considered as a group with a max. characteristic resistance $N_{Rk,p}$ acc. to Table C 1.1, C 2.1. For $a > 80$ mm, the anchors are considered as single anchors, each with a characteristic resistance $N_{Rk,p}$ acc. to Table C 1.1, C 2.1.
- SHARK PRO 12:** Fixing points with a spacing $a \leq 100$ mm are considered as a group with a max. characteristic resistance $N_{Rk,p}$ acc. to Table C 1.1, C 2.1. For $a > 100$ mm, the anchors are considered as single anchors, each with a characteristic resistance $N_{Rk,p}$ acc. to Table C 1.1, C 2.1.
- SHARK PRO 14:** Fixing points with a spacing $a \leq 110$ mm are considered as a group with a max. characteristic resistance $N_{Rk,p}$ acc. to Table C 1.1, C 2.1. For $a > 110$ mm, the anchors are considered as single anchors, each with a characteristic resistance $N_{Rk,p}$ acc. to Table C 1.1, C 2.1.

		h_{nom} [mm]	h_{min} [mm]	$C_{cr,N}$ [mm]	C_{min} [mm]	S_{min} [mm]
SHARK PRO 8	Concrete \geq C16/20	34	100	80	80	80
	Concrete C12/15	34	100	120	110	110
SHARK PRO 8	Concrete \geq C16/20	45	100	80	80	80
	Concrete C12/15	45	100	110	110	110
SHARK PRO 10	Concrete \geq C16/20	55	100	80	80	80
	Concrete C12/15	55	100	110	110	110
SHARK PRO 12	Concrete \geq C16/20	57	65	120	150	150
	Concrete C12/15	57	65	210	210	210
SHARK PRO 14	Concrete \geq C16/20	75	120	150	150	150
	Concrete C12/15	75	120	210	210	210

Concrete:

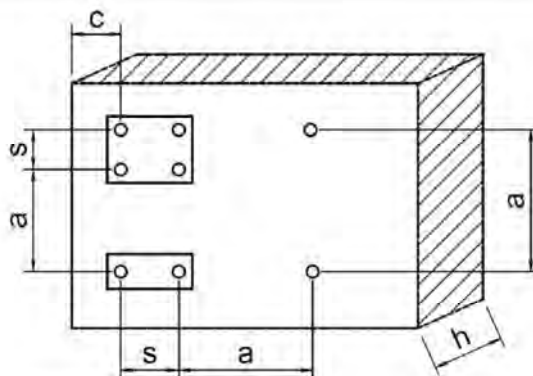

SHARK PRO

Intended use
Minimum thickness, edge distances and spacing for use concrete

Annex B 3

Table B 3.1: Minimum thickness of member, edge distance and anchor spacing in masonry and autoclaved aerated concrete

			Masonry		Autoclaved aerated concrete			
					AAC 4	AAC 6	AAC 4	AAC 6
Anchor type SHARK PRO			10	12	10		12	
Minimum thickness of member	h_{\min}	[mm]	100 ¹⁾	100 ¹⁾	175		175	
Single anchor								
Minimum spacing	a_{\min}	[mm]	250	250	250		250	
Minimum edge distance	c_{\min}	[mm]	100	100	80	100	100	100
Anchor group								
Spacing perpendicular to free edge	$s_{1,\min}$	[mm]	200	200 ¹⁾	100	125	100	100
Spacing parallel to free edge	$s_{2,\min}$	[mm]	250	250 ¹⁾	100	125	250	250
Minimum allowable edge distance	c_{\min}	[mm]	100 ¹⁾	100 ¹⁾	80	100	100	100

¹⁾ depends on the brick size (see the following annexes C 7 - C 21)

Masonry and autoclaved aerated concrete

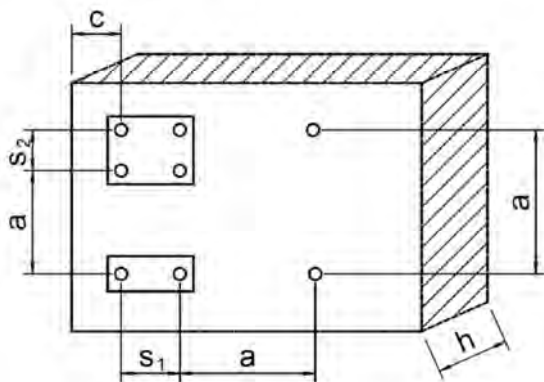

SHARK PRO

Intended use



Minimum member thickness, edge distances and spacings for use in masonry and AAC

Annex B 4

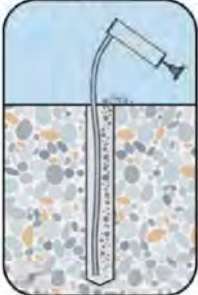
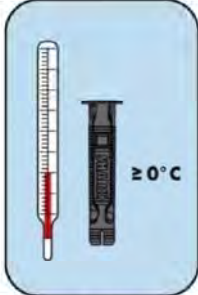
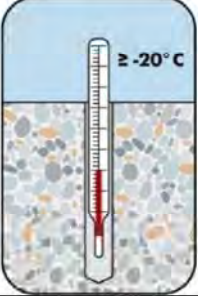
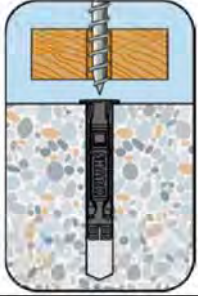
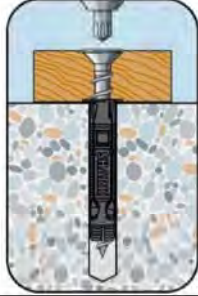
Installation instructions pre-positioned installation

		
<p>1) Drill the bore hole</p>	<p>2) Clean the drilled bore hole</p>	<p>3) Temperature anchor sleeve $\geq 0^{\circ}\text{C}$</p>
		
<p>4) Temperature anchoring base $\geq -20^{\circ}\text{C}$</p>	<p>5) Set anchor in place, before screwing it must be checked that the hole of the fixture is positioned axial over the anchor sleeve</p>	<p>6) screw in the screw through the fixture until flush</p>

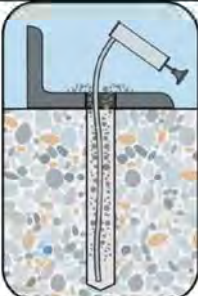
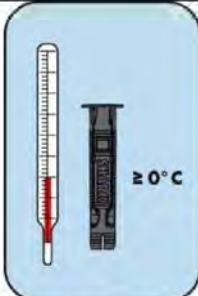
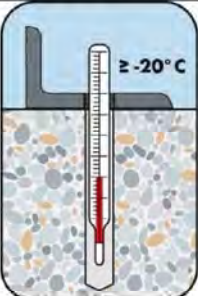
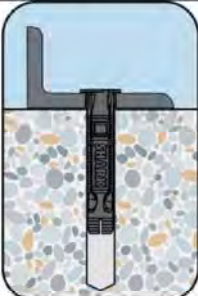
Installation instructions in-place installation

		
<p>1) Drill the bore hole</p>	<p>2) Clean the drilled bore hole</p>	<p>3) Temperature anchor sleeve $\geq 0^{\circ}\text{C}$</p>
		
<p>4) Temperature anchoring base $\geq -20^{\circ}\text{C}$</p>	<p>5) Set anchor in place</p>	<p>6) Screw in the screw until flush</p>

SHARK PRO

Intended use

Installation instructions pre-positioned installation and in-place installation

Annex B 5

Table C 1.1: Characteristic resistance of the screw, galvanized steel for use in concrete

Anchor type			SHARK PRO, galvanised steel				
			6	8	10	12	14
Failure of expansion element (special screw)							
Overall plastic anchor embedment depth	h_{nom}	[mm]	34	45	55	57 65	75
Characteristic tension resistance	$N_{Rk,s}$	[kN]	5.66	9.07	16,34	23.76	29.91
Partial safety factor	$\gamma_{Ms}^{1)}$	[-]	1.5	1.5	1.5	1.5	1.5
Characteristic shear resistance	$V_{Rk,s}$	[kN]	2.83	4.54	8.17	11.88	14.96
Partial safety factor	$\gamma_{Ms}^{1)}$	[-]	1.25	1.25	1.25	1.25	1.25
Characteristic bending resistance	$M_{Rk,s}$	[Nm]	2.54	5.17	12.50	21.92	30.96
Partial safety factor	$\gamma_{Ms}^{1)}$	[-]	1.25	1.25	1.25	1.25	1.25
Pull-out failure (plastic sleeve)							
Concrete \geq C16/20							
Characteristic resistance 24°C ²⁾ / 40°C ³⁾	$N_{Rk,p}$	[kN]	0.9	1.2	4.0	5.0	6.0
Partial safety factor	$\gamma_{Mc}^{1)}$	[-]	1.8	1.8	1.8	1.8	1.8
Concrete = C12/15							
Characteristic resistance 24°C ²⁾ / 40°C ³⁾	$N_{Rk,p}$	[kN]	0.9	0.9	3.0	4.0	5.0
Partial safety factor	$\gamma_{Mc}^{1)}$	[-]	1.8	1.8	1.8	1.8	1.8

1) In absence of other national regulations

2) Maximum long term temperature

3) Maximum short term temperature

SHARK PRO

Performances

Characteristic resistance of the screw, galvanized steel for use in concrete

Annex C 1

Table C 2.1: Characteristic resistance, stainless steel for use in concrete

Anchor type			SHARK PRO, stainless steel					
			6	8	10	12	14	
Failure of expansion element (special screw)								
Overall plastic anchor embedment depth	h_{nom}	[mm]	34	45	55	57	65	75
Characteristic tension resistance	$N_{Rk,s}$	[kN]	4.95	8.37	15.44	20.79		26.17
Partial safety factor	$\gamma_{Ms}^{1)}$	[-]	1.87	1.87	1.87	1.87		1.87
Characteristic shear resistance	$V_{Rk,s}$	[kN]	2.47	3.97	7.15	10.40		13.09
Partial safety factor	$\gamma_{Ms}^{1)}$	[-]	1.56	1.56	1.56	1.56		1.56
Characteristic bending resistance	$M_{Rk,s}$	[Nm]	2.23	4.53	10.94	19.18		27.09
Partial safety factor	$\gamma_{Ms}^{1)}$	[mm]	1.56	1.56	1.56	1.56		1.56
Pull-out failure (plastic sleeve)								
Concrete \geq C16/20								
Characteristic resistance $24^{\circ}C^{2)}/40^{\circ}C^{3)}$	$N_{Rk,p}$	[kN]	0.9	1.2	4.0	5.0		6.0
Partial safety factor	$\gamma_{Mc}^{1)}$	[-]	1.8	1.8	1.8	1.8		1.8
Concrete = C12/15								
Characteristic resistance $24^{\circ}C^{2)}/40^{\circ}C^{3)}$	$N_{Rk,p}$	[kN]	0.9	0.9	3.0	4.0		5.0
Partial safety factor	$\gamma_{Mc}^{1)}$	[-]	1.8	1.8	1.8	1.8		1.8

¹⁾ In absence of other national regulations

²⁾ Maximum long term temperature

³⁾ Maximum short term temperature

SHARK PRO

Performances

Characteristic resistance of the screw, stainless steel for use in concrete

Annex C 2

Table C 3.1: Displacements ¹⁾ under tension and shear loading in concrete and masonry

Anchor type	h _{nom} [mm]	Tension load			Shear load		
		F ²⁾ [kN]	δ _{N0} [mm]	δ _{N∞} [mm]	F ²⁾ [kN]	δ _{V0} [mm]	δ _{V∞} [mm]
SHARK PRO 6	≥ 34	0.5	0.11	0.22	0.5	0.8	1.2
SHARK PRO 8	≥ 45	0.5	0.13	0.26	0.6	1.99	2.99
SHARK PRO 10	≥ 55	1.6	0.16	0.32	1.4	1.15	1.73
SHARK PRO 12	≥ 57	2.0	0.35	0.7	2.0	1.77	2.66
SHARK PRO 14	≥ 75	2.8	0.41	0.82	2.8	1.61	2.42

¹⁾ Valid for all ranges of temperatures

²⁾ Intermediate values by linear interpolation

Table C 3.2: Displacements ¹⁾ under tension and shear loading in AAC

Anchor type	h _{nom} [mm]	Tension			Shear load		
		F ²⁾ [kN]	δ _{N0} [mm]	δ _{N∞} [mm]	F ²⁾ [kN]	δ _{V0} [mm]	δ _{V∞} [mm]
SHARK PRO 10	55	0.1	0.1	0.2	0.1	0.2	0.3
SHARK PRO 12	57	0.43	0.22	0.44	0,43	0,86	1,29

¹⁾ Valid for all ranges of temperatures

²⁾ Intermediate values by linear interpolation

Table C3.3: Values under fire exposure in concrete C20/25 to C50/60 in any load direction, no permanent centric tension load and without lever arm, fastening of façade systems

Anchor type	Fire resistance class	F ¹⁾
SHARK PRO 10	R 90	≤ 0,8 kN
SHARK PRO 12	R 90	≤ 0,8 kN
SHARK PRO 14	R 90	≤ 0,8 kN

¹⁾ $F_{Rk} / (\gamma_m \times \gamma_F)$

Footnotes for Annex C 7- C 21

- 1) Characteristic resistance F_{Rk} for tension, shear or combined tension and shear loading.
The characteristic resistance is valid for single plastic anchor or for a group of two or four plastic anchors with a spacing equal or larger than the minimum spacing s_{min} according to Table B 3.1. The specific conditions for the design method have to be considered according to ETAG 020 Anhang C.
- 2) In absence of other national regulations
- 3) Maximum long term temperature
- 4) Maximum short term temperature

SHARK PRO

Performances

Displacements under tension and shear loading in concrete, masonry and autoclaved aerated concrete, values under fire exposure in concrete

Annex C 3

Table C 4.1: Base material: Concrete and solid masonry

Base material	Format	Measurement [mm]	Minimum compressive strength [N/mm ²]	Bulk density class [kg/dm ³]	Annex
Concrete (use category "a")					
Concrete ≥ C12/15					Annex C 1 Annex C 2
Solid masonry (use category "b")					
Solid brick Mz acc. to DIN 105-100: 2012-01 EN 771-1:2011 e.g. Wienerberger GmbH	≥ NF	≥ 240x115x71	10 20 28 36 47	≥ 1.8	Annex C 7 771-1-020
	≥ 3DF	240x175x113	10 12 20 26		Annex C 8 771-1-041
Sand-lime solid brick KS acc. to DIN V 106:2005-10 EN 771-2:2011	≥ NF	≥ 240x115x71	10 20 28 39,5	≥ 2.0	Annex C 11 771-2-011
Sand-lime solid brick Silka XL Basic, Sand-lime solid brick Silka XL Plus, DIN V 106:2005-10 EN 771-2:2011 Z-17.1-997 e. g. Xella International GmbH	-	≥ 498x240x498	10 20 28	≥ 1.6	Annex C 12 771-2-028 771-2-010
Concrete solid block Vn and Vbn acc. to DIN 18153-100:2005-10 EN 771-3:2011 Bisotherm GmbH	≥ NF	≥ 240x115x71	10 20 28 35,1	≥ 2.0	Annex C 16 771-3-004
Lightweight concrete solid block V and Vbl , e.g. Bisophon acc. to DIN V 18152-100:2005-10 EN 771-3:2011 Bisotherm GmbH	≥ 3DF	≥ 240x175x113	10 20 25	≥ 2.0	Annex C 17 771-3-017
Lighweight concrete solid block V and Vbl , e.g. BasisoBims acc. DIN V 18152-100:2005-10 EN 771-3:2011 Bisotherm GmbH	≥ NF	≥ 240x115x71	4 6	≥ 1.2	Annex C 18 771-3-007
Lighweight concrete solid block V and Vbl , e.g. Bisophon acc. DIN V 18152-100:2005-10 EN 771-3:2011 Bisotherm GmbH	≥ 3DF	≥ 240x175x113	2 4 6	≥ 1.2	Annex C 19 771-3-016

SHARK PRO

Performances

Concrete (use category "a") and solid masonry (use category "b") - format, measurement, minimum compressive strength, bulk density, Annex

Annex C 4

Table C 5.1: Base material: Hollow or perforated masonry

Base material	Format	Measurement [mm]	Minimum compressive strength [N/mm ²]	Bulk density class [kg/dm ³]	Annex
Hollow or perforated masonry (use category "c")					
Hollow brick HLz acc. to DIN 105-100: 2012-01 EN 771-1:2011 e.g. Wienerberger GmbH e.g. Schlagmann Baustoffwerke GmbH & Co. KG	≥ 12DF	≥ 373x240x238	4 6 8 10	≥ 1.2	Annex C 9 771-1-036
Hollow brick HLz acc. to DIN 105-100: 2012-01 EN 771-1:2011 e.g. Wienerberger GmbH e.g. Schlagmann Baustoffwerke GmbH & Co. KG	≥ 9 DF	≥ 373x175x238	10 20 30	≥ 1.2	Annex C 10 771-1-055
Sand-lime perforated brick KS L acc. to DIN V 106:2005-10 EN 771-2:2011	≥ 2DF	≥ 240x115x113	8 10 12 20 24	≥ 1.4	Annex C 13 771-2-012 771-2-004
Sand-lime perforated brick KS L acc. to DIN V 106:2005-10 EN 771-2:2011 e. g. Xella International GmbH	≥ 8DF	≥ 248x240x238	6 8 10 12 14.4	≥ 1.4	Annex C 14 771-2-013
Sand-lime perforated brick KS L acc. to DIN V 106:2005-10 EN 771-2:2011 e. g. Heidelberger Kalksandstein GmbH	≥ 12DF	≥ 498x175x248	6 8 10 12 23	1,4	Annex C 15 771-2-044

SHARK PRO

Performances

Hollow or perforated masonry (use category "c") - format, measurement, minimum compressive strength, bulk density, Annex

Annex C 5

Table C 6.1: Base material: Autoclaved aerated concrete (use category "d")

Base material	Format	Measurement [mm]	Minimum compressive strength [N/mm ²]	Bulk density class [kg/dm ³]	Annex
Autoclaved aerated concrete AAC acc. to EN 771-4:2011	-	≥ 499x175x249	4 - 7	≥ 0.3	Annex C 20

Table C 7.1: Base material: Precast prestressed hollow core slabs

Base material	Format	Measurement [mm]	Minimum compressive strength [N/mm ²]	Bulk density class [kg/dm ³]	Annex
Precast prestressed hollow core slabs acc. to DIN EN 1168:2011-12	-	-	≥ C30/37	-	Annex C 21

SHARK PRO

Performances

Autoclaved aerated concrete (use category "d") and precast or prestressed hollow core elements -measurement, minimum compressive strength, bulk density class, Annex

Annex C 6

Base material solid masonry: Solid brick Mz, NF

Table C 8.1.1 Brick data

Description of brick		771-1-020	Mz
Type of brick			Solid brick Mz
Bulk density	$\rho \geq$	[kg/dm ³]	1.8
Standard, approval			DIN 105-100: 2012-01; EN 771-1:2011
Format (measurement)		[mm]	\geq NF (\geq 240x115x71)
Minimum thickness of member	$h_{\min} =$	[mm]	115

Table C 8.1.2 Installation parameters

Anchor size SHARK PRO			10	12
Drill hole diameter	$d_0 =$	[mm]	10	12
Cutting diameter of drill bit	$d_{\text{cut}} \leq$	[mm]	10.45	12,45
Depth of drill hole to deepest point	$h_1 \geq$	[mm]	$l_s + 5 \text{ mm} - t_{\text{fix}}$	
Drill method		[-]	Hammer drilling	
Overall plastic anchor embedment depth pre-positioned installation	$h_{\text{nom}} \geq$	[mm]	55	65
Overall plastic anchor embedment depth in-place installation	$h_{\text{nom}} \geq$	[mm]	-	55
Diameter of clearance hole in the fixture pre-positioned installation	$d_f \leq$	[mm]	8.5	10,5
Diameter of clearance hole in the fixture in-place installation	$d_f \leq$	[mm]	-	14,5
Minimum spacing	$s_{1,\min} = s_{2,\min} \geq$	[mm]	-	75 250
Minimum edge distance	$c_{\min} \geq$	[mm]	100	250 100

Table C 8.1.3 Characteristic resistance F_{Rk}^1 in [kN] for single anchor

Anchor size SHARK PRO			10	12
Solid brick Mz, $f_b \geq 10 \text{ N/mm}^2$ Characteristic resistance F_{Rk}	$24^\circ\text{C}^3 / 40^\circ\text{C}^4$	[kN]	0.9	0.9 0.40
Solid brick Mz, $f_b \geq 20 \text{ N/mm}^2$ Characteristic resistance F_{Rk}	$24^\circ\text{C}^3 / 40^\circ\text{C}^4$	[kN]	1.5	1.5 0.50
Solid brick Mz, $f_b \geq 28 \text{ N/mm}^2$ Characteristic resistance F_{Rk}	$24^\circ\text{C}^3 / 40^\circ\text{C}^4$	[kN]	2.0	2.0 0.75
Solid brick Mz, $f_b \geq 36 \text{ N/mm}^2$ Characteristic resistance F_{Rk}	$24^\circ\text{C}^3 / 40^\circ\text{C}^4$	[kN]	2.5	2.5 0.9
Solid brick Mz, $f_b \geq 47,4 \text{ N/mm}^2$ Characteristic resistance F_{Rk}	$24^\circ\text{C}^3 / 40^\circ\text{C}^4$	[kN]	3.5	3.5 1.2
Partial safety factor	γ_{Mm}^2	[-]	2.5	

Footnotes see Annex C 3

SHARK PRO

Solid masonry: Solid brick Mz, NF
Brick data, installation parameters, characteristic resistance

Annex C 7

Base material solid masonry: Solid brick Mz, 3DF

Table C 8.2.1: Brick data

Description of brick		771-1-041	Mz
Type of brick			Solid brick Mz
Bulk density	$\rho \geq$	[kg/dm ³]	1.8
Standard, approval			DIN 105-100: 2012-01; EN 771-1:2011
Producer of brick			e.g. Wienerberger GmbH
Format (measurement)		[mm]	$\geq 3DF (\geq 240 \times 175 \times 113)$
Minimum thickness of member	$h_{\min} =$	[mm]	175

Table C 8.2.2: Installation parameters

Anchor size SHARK PRO			10
Drill hole diameter	$d_0 =$	[mm]	10
Cutting diameter of drill bit	$d_{\text{cut}} \leq$	[mm]	10.45
Depth of drill hole to deepest point	$h_1 \geq$	[mm]	$l_s + 5 \text{ mm} - t_{\text{fix}}$
Drill method		[-]	Hammer drilling
Overall plastic anchor embedment depth	$h_{\text{nom}} \geq$	[mm]	55
Diameter of clearance hole in the fixture	$d_f \leq$	[mm]	8.5
Minimum edge distance	$c_{\min} \geq$	[mm]	55 100

Table C 8.2.3: Characteristic resistance $F_{Rk}^{1)}$ in [kN] for single anchor

Anchor size SHARK PRO			10	
Solid brick Mz, $f_b \geq 8 \text{ N/mm}^2$ Characteristic resistance F_{Rk}	$24^\circ\text{C}^{3)} / 40^\circ\text{C}^{4)}$	[kN]	0.75	0.9
Solid brick Mz, $f_b \geq 12 \text{ N/mm}^2$ Characteristic resistance F_{Rk}	$24^\circ\text{C}^{3)} / 40^\circ\text{C}^{4)}$	[kN]	1.2	-
Solid brick Mz, $f_b \geq 20 \text{ N/mm}^2$ Characteristic resistance F_{Rk}	$24^\circ\text{C}^{3)} / 40^\circ\text{C}^{4)}$	[kN]	2.0	1.5
Solid brick Mz, $f_b \geq 26 \text{ N/mm}^2$ Characteristic resistance F_{Rk}	$24^\circ\text{C}^{3)} / 40^\circ\text{C}^{4)}$	[kN]	2.0	2.0
Partial safety factor	$\gamma_{Mm}^{2)}$	[-]	2.5	

Footnotes see Annex C 3

SHARK PRO

Performances

Solid masonry: Solid brick Mz, 3DF
Brick data, installation parameters, characteristic resistance

Annex C 8

Base material hollow masonry: Hollow brick HLz, 12DF

Table C 8.3.1: Brick data

Description of brick	771-1-036	HLz
Type of brick		Hollow brick
Bulk density	$\rho \geq$ [kg/dm ³]	1.2
Standard, approval		DIN 105-100: 2012-01; EN 771-1:2011
Producer of brick		e.g. Schlagmann Baustoffwerke GmbH & Co. KG
Format (measurement)	[mm]	\geq 12DF (\geq 373x240x238)
Minimum thickness of member	$h_{\min} =$ [mm]	240

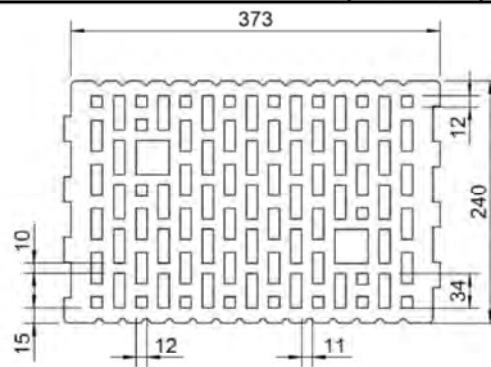

Table C 8.3.2: Installation parameters

Anchor size SHARK PRO		10
Drill hole diameter	$d_0 =$ [mm]	10
Cutting diameter of drill bit	$d_{\text{cut}} \leq$ [mm]	10.45
Depth of drill hole to deepest point	$h_1 \geq$ [mm]	$l_s + 5 \text{ mm} - t_{\text{fix}}$
Drill method	[-]	Rotary drilling
Overall plastic anchor embedment depth	$h_{\text{nom}} =$ [mm]	55
Diameter of clearance hole in the fixture	$d_f \leq$ [mm]	8.5
Minimum edge distance	$c_{\min} \geq$ [mm]	100

Table C 8.3.3: Characteristic resistance F_{Rk} ¹⁾ in [kN] for single anchor

Anchor size SHARK PRO		10
Hollow brick HLz, $f_b \geq 4 \text{ N/mm}^2$	24°C ³⁾ / 40°C ⁴⁾	0.9
Characteristic resistance F_{Rk}	[kN]	
Hollow brick HLz, $f_b \geq 6 \text{ N/mm}^2$	24°C ³⁾ / 40°C ⁴⁾	1.5
Characteristic resistance F_{Rk}	[kN]	
Hollow brick HLz, $f_b \geq 8 \text{ N/mm}^2$	24°C ³⁾ / 40°C ⁴⁾	2.0
Characteristic resistance F_{Rk}	[kN]	
Hollow brick HLz, $f_b \geq 10 \text{ N/mm}^2$	24°C ³⁾ / 40°C ⁴⁾	2.5
Characteristic resistance F_{Rk}	[kN]	
Partial safety factor	γ_{Mm} ²⁾ [-]	2.5

Footnotes see Annex C 3

SHARK PRO

Performances

Hollow masonry: Hollow brick HLz, 12DF
Brick data, installation parameters, characteristic resistance

Annex C 9

Base material hollow masonry: Hollow brick HLz, 9DF

Table C 8.4.1: Brick data

Description of brick		771-1-055	HLz
Type of brick			Hollow brick
Bulk density	$\rho \geq$	[kg/dm ³]	1.2
Standard, approval			DIN 105-100: 2012-01; EN 771-1:2011
Producer of brick			e.g. Schlagmann Baustoffwerke GmbH & Co. KG
Format (measurement)		[mm]	\geq 9DF (\geq 373x175x238)
Minimum thickness of member	$h_{\min} =$	[mm]	175

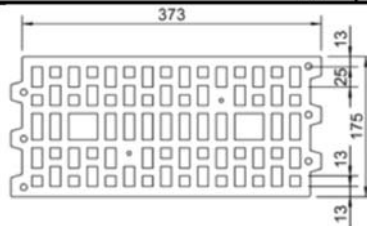

Table C 8.4.2: Installation parameters

Anchor size SHARK PRO		12
Drill hole diameter	$d_0 =$	[mm] 12
Cutting diameter of drill bit	$d_{\text{cut}} \leq$	[mm] 12.45
Depth of drill hole to deepest point	$h_1 \geq$	[mm] $l_s + 5 \text{ mm} - t_{\text{fix}}$
Drill method		[-] Rotary drilling
Overall plastic anchor embedment depth pre-positioned installation	$h_{\text{nom}} =$	65
Overall plastic anchor embedment depth in-place installation	$h_{\text{nom}} =$	[mm] 57
Diameter of clearance hole in the fixture pre-positioned installation	$d_f \leq$	[mm] 10,5
Diameter of clearance hole in the fixture in-place installation	$d_f \leq$	14,5
Minimum spacing	$s_{1,\min} = s_{2,\min} \geq$	75 250
Minimum edge distance	$c_{\min} \geq$	[mm] 195 100

Table C 8.4.3: Characteristic resistance $F_{RK}^{1)}$ in [kN] for single anchor

Anchor size SHARK PRO		12
Hollow brick HLz, $f_b \geq 10 \text{ N/mm}^2$	$24^\circ\text{C}^{3)} / 40^\circ\text{C}^{4)}$	[kN] 0.75
Hollow brick HLz, $f_b \geq 20 \text{ N/mm}^2$	$24^\circ\text{C}^{3)} / 40^\circ\text{C}^{4)}$	[kN] 1.5
Hollow brick HLz, $f_b \geq 30 \text{ N/mm}^2$	$24^\circ\text{C}^{3)} / 40^\circ\text{C}^{4)}$	[kN] 2.5
Partial safety factor	$\gamma_{Mm}^{2)}$	[-] 2.5

Footnotes see Annex C 3

SHARK PRO

Performances

Hollow masonry: Hollow brick HLz, 9DF
Brick data, installation parameters, characteristic resistance

Annex C 10

Base material solid masonry, sand-lime solid brick KS, NF

Table C 8.5.1: Brick data

Description of brick		771-2-011	KS
Type of brick			Sand-lime solid brick
Bulk density	$\rho \geq$	[kg/dm ³]	2.0
Standard, approval			DIN V 106:2005-10; EN 771-2:2011
Producer of brick			e.g. Xella International GmbH Dr.-Hammacher-Str. 49 D-47119 Duisburg
Format (measurement)		[mm]	\geq NF ($\geq 240 \times 115 \times 71$)
Minimum thickness of member	$h_{\min} =$	[mm]	115

Table C 8.5.2: Installation parameters

Anchor size SHARK PRO			10	
Drill hole diameter	$d_0 =$	[mm]	10	
Cutting diameter of drill bit	$d_{\text{cut}} \leq$	[mm]	10.45	
Depth of drill hole to deepest point	$h_1 \geq$	[mm]	$l_s + 5 \text{ mm} - t_{\text{fix}}$	
Drill method		[-]	Hammer drilling	
Overall plastic anchor embedment depth	$h_{\text{nom}} =$	[mm]	55	
Diameter of clearance hole in the fixture	$d_f \leq$	[mm]	8.5	
Minimum allowable edge distance	$c_{\min} \geq$	[mm]	100	250

Table C 8.5.3: Characteristic resistance F_{RK}^1 in [kN] for single anchor

Anchor size SHARK PRO			10	
Sand-lime solid brick KS, $f_b \geq 10 \text{ N/mm}^2$	$24^\circ\text{C}^3 / 40^\circ\text{C}^4$	[kN]	0.75	1.2
Characteristic resistance F_{RK}				
Sand-lime solid brick KS, $f_b \geq 20 \text{ N/mm}^2$	$24^\circ\text{C}^3 / 40^\circ\text{C}^4$	[kN]	1.2	2.0
Characteristic resistance F_{RK}				
Sand-lime solid brick KS, $f_b \geq 28 \text{ N/mm}^2$	$24^\circ\text{C}^3 / 40^\circ\text{C}^4$	[kN]	1.5	2.5
Characteristic resistance F_{RK}				
Sand-lime solid brick KS, $f_b \geq 39,5 \text{ N/mm}^2$	$24^\circ\text{C}^3 / 40^\circ\text{C}^4$	[kN]	2.0	3.5
Characteristic resistance F_{RK}				
Partial safety factor	γ_{Mm}^2	[-]	2.5	

Footnotes see Annex C 3

SHARK PRO

Performances

Solid masonry: Sand-lime solid brick KS, NF
Brick data, installation parameters, characteristic resistance

Annex C 11

Base material solid masonry, sand-lime solid brick Silka XL Basic, Silka XL Plus

Table C 8.6.1: Brick data

Description of brick		771-1-028	Silka XL Basic, Silka XL Plus
Type of brick			Sand-lime solid brick
Bulk density	$\rho \geq$	[kg/dm ³]	1.6
Standard, approval			DIN V 106:2005-10; EN 771-2:2011; Z-17.1-997
Producer of brick			z.B. Xella International GmbH Dr.-Hammacher-Str. 49 D-47119 Duisburg
Format (measurement)		[mm]	($\geq 498 \times 240 \times 498$)
Minimum thickness of member	$h_{\min} =$	[mm]	240

Table C 8.6.2: Installation parameters

Anchor size SHARK PRO			12
Drill hole diameter	$d_0 =$	[mm]	12
Cutting diameter of drill bit	$d_{\text{cut}} \leq$	[mm]	12.45
Depth of drill hole to deepest point	$h_1 \geq$	[mm]	$l_s + 5 \text{ mm} - t_{\text{fix}}$
Drill method		[-]	Hammer drilling
Overall plastic anchor embedment depth pre-positioned installation	$h_{\text{nom}} =$		65
Overall plastic anchor embedment depth in-place installation	$h_{\text{nom}} =$	[mm]	57
Diameter of clearance hole in the fixture pre-positioned installation	$d_f \leq$	[mm]	10,5
Diameter of clearance hole in the fixture in-place installation	$d_f \leq$		14,5
Minimum spacing	$s_{1,\min} = s_{2,\min} \geq$		75 250
Minimum edge distance	$c_{\min} \geq$	[mm]	150 100

Table C 8.6.3: Characteristic resistance $F_{Rk}^{1)}$ in [kN] for single anchor

Anchor size SHARK PRO			12
Sand-lime solid brick Silka XL Basic $f_b \geq 10 \text{ N/mm}^2$	$24^\circ\text{C}^{3)} / 40^\circ\text{C}^{4)}$	[kN]	2.5
Characteristic resistance F_{Rk}			
Sand-lime solid brick Silka XL Basic $f_b \geq 20 \text{ N/mm}^2$	$24^\circ\text{C}^{3)} / 40^\circ\text{C}^{4)}$	[kN]	3.5
Characteristic resistance F_{Rk}			
Sand-lime solid brick Silka XL Basic $f_b \geq 28 \text{ N/mm}^2$	$24^\circ\text{C}^{3)} / 40^\circ\text{C}^{4)}$	[kN]	4,0
Characteristic resistance F_{Rk}			
Partial safety factor	$\gamma_{Mm}^{2)}$	[-]	2.5

Footnotes see Annex C 3

SHARK PRO

Performances

Solid masonry: Sand-lime solid brick Silka XL Basic
Brick data, installation parameters, characteristic resistance

Annex C 12

Base material hollow masonry, sand-lime perforated brick KS L, 2DF

Table C 8.7.1: Brick data

Description of brick		771-2-004, 771-2-012	KS L
Type of brick			Sand-lime perforated brick
Bulk density	$\rho \geq$ [kg/dm ³]		1.4
Standard, approval			DIN V 106:2005-10; EN 771-2:2011
Producer of brick			-
Format (measurement)	[mm]		\geq 2DF (\geq 240x115x113)
Minimum thickness of member	$h_{\min} =$ [mm]		115

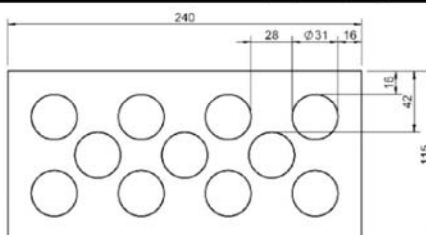

Table C 8.7.2: Installation parameters

Anchor size SHARK PRO		10	12
Drill hole diameter	d_0 [mm]	10	12
Cutting diameter of drill bit	$d_{\text{cut}} \leq$ [mm]	10.45	12.45
Depth of drill hole to deepest point	$h_1 \geq$ [mm]	$l_s + 5 \text{ mm} - t_{\text{fix}}$	
Drill method	[-]	Rotary drilling	
Overall plastic anchor embedment depth pre-positioned installation	$h_{\text{nom}} =$	55	65
Overall plastic anchor embedment depth in-place installation	$h_{\text{nom}} =$ [mm]	-	57
Diameter of clearance hole in the fixture pre-positioned installation	$d_f \leq$ [mm]	8.5	10.5
Diameter of clearance hole in the fixture in-place installation	$d_f \leq$ [mm]	-	14.5
Minimum edge distance	$c_{\min} \geq$ [mm]	100	100

Table C 8.7.3: Characteristic resistance $F_{Rk}^{1)}$ in [kN] for single anchor

Anchor size SHARK PRO		10	12
Sand-lime perforated brick KS L, $f_b \geq 8$ N/mm ² Characteristic resistance F_{Rk}	24°C ³⁾ / 40°C ⁴⁾ [kN]	0.9	-
Sand-lime perforated brick KS L, $f_b \geq 10$ N/mm ² Characteristic resistance F_{Rk}	24°C ³⁾ / 40°C ⁴⁾ [kN]	1.2	0.9
Sand-lime perforated brick KS L, $f_b \geq 12$ N/mm ² Characteristic resistance F_{Rk}	24°C ³⁾ / 40°C ⁴⁾ [kN]	1.5	-
Sand-lime perforated brick KS L, $f_b \geq 20$ N/mm ² Characteristic resistance F_{Rk}	24°C ³⁾ / 40°C ⁴⁾ [kN]	2.5	2.0
Sand-lime perforated brick KS L, $f_b \geq 24$ N/mm ² Characteristic resistance F_{Rk}	24°C ³⁾ / 40°C ⁴⁾ [kN]	2.5	2.5
Partial safety factor	$\gamma_{Mm}^{2)}$ [-]	2.5	

Footnotes see Annex C 3

SHARK PRO

Performances

Hollow masonry: Sand-lime perforated brick KS L, 2DF
Brick data, installation parameters, characteristic resistance

Annex C 13

Base material hollow masonry, sand-lime perforated brick KS L, 8DF

Table C 8.8.1: Brick data

Description of brick		771-2-013	KS L
Type of brick			Sand-lime perforated brick
Bulk density	$\rho \geq$	[kg/dm ³]	1.4
Standard, approval			DIN V 106:2005-10; EN 771-2:2011
Producer of brick			e.g. Xella International GmbH
Format (measurement)		[mm]	$\geq 8DF (\geq 248 \times 240 \times 238)$
Minimum thickness of member	$h_{min} =$	[mm]	240

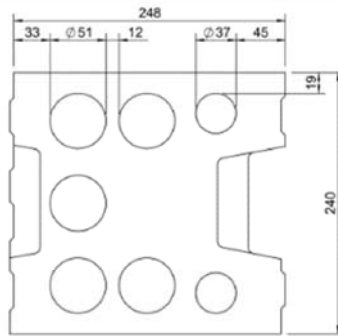

Table C 8.8.2: Installation parameters

Anchor size SHARK PRO			10	12
Drill hole diameter	$d_0 =$	[mm]	10	12
Cutting diameter of drill bit	$d_{cut} \leq$	[mm]	10.45	12.45
Depth of drill hole to deepest point	$h_1 \geq$	[mm]	$l_s + 5 \text{ mm} - t_{fix}$	
Drill method		[-]	Rotary drilling	
Overall plastic anchor embedment depth pre-positioned installation	$h_{nom} =$	[mm]	55	65
Overall plastic anchor embedment depth in-place installation	$h_{nom} =$	[mm]	-	57
Diameter of clearance hole in the fixture pre-positioned inst.	$d_f \leq$	[mm]	8.5	10.5
Diameter of clearance hole in the fixture in-place inst.	$d_f \leq$	[mm]	-	14.5
Minimum edge distance	$c_{min} \geq$	[mm]	100	100

Table C 8.8.3: Characteristic resistance F_{Rk} ¹⁾ in [kN] for single anchor

Anchor size SHARK PRO			10	12
Sand-lime perforated brick KS L, $f_b \geq 6$ N/mm², Characteristic resistance F_{Rk}	$24^\circ C^3) / 40^\circ C^4)$	[kN]	0.9	0.9
Sand-lime perforated brick KS L, $f_b \geq 8$ N/mm², Characteristic resistance F_{Rk}	$24^\circ C^3) / 40^\circ C^4)$	[kN]	1.2	1.2
Sand-lime perforated brick KS L, $f_b \geq 10$ N/mm², Characteristic resistance F_{Rk}	$24^\circ C^3) / 40^\circ C^4)$	[kN]	1.5	1.5
Sand-lime perforated brick KS L, $f_b \geq 12$ N/mm², Characteristic resistance F_{Rk}	$24^\circ C^3) / 40^\circ C^4)$	[kN]	2.0	2.0
Sand-lime perforated brick KS L, $f_b \geq 14,4$ N/mm², Characteristic resistance F_{Rk}	$24^\circ C^3) / 40^\circ C^4)$	[kN]	2.5	2.5
Partial safety factor	$\gamma_{Mm}^2)$	[-]	2.5	

Footnotes see Annex C 3

SHARK PRO

Performances

Hollow masonry: Sand-lime perforated brick KS L, 8DF
Brick data, installation parameters, characteristic resistance

Annex C 14

Base material hollow masonry, sand-lime perforated brick KS L, 12DF

Table C 8.9.1: Brick data

Description of brick		771-2-044	KS L
Type of brick			Sand-lime perforated brick
Bulk density	$\rho \geq$	[kg/dm ³]	1.4
Standard, approval			DIN V 106:2005-10; EN 771-2:2011
Producer of brick			z.B. Heidelberger Kalksandstein GmbH
Format (measurement)		[mm]	$\geq 12DF (\geq 498 \times 175 \times 247)$
Minimum thickness of member	$h_{\min} =$	[mm]	175

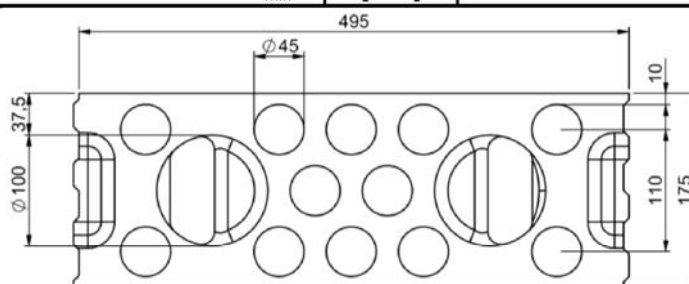

Table C 8.9.2: Installation parameters

Anchor size SHARK PRO			12
Drill hole diameter	$d_0 =$	[mm]	12
Cutting diameter of drill bit	$d_{\text{cut}} \leq$	[mm]	12.45
Depth of drill hole to deepest point	$h_1 \geq$	[mm]	$l_s + 5 \text{ mm} - t_{\text{fix}}$
Drill method		[-]	Rotary drilling
Overall plastic anchor embedment depth pre-positioned installation	$h_{\text{nom}} =$		65
Overall plastic anchor embedment depth in-place installation	$h_{\text{nom}} =$	[mm]	57
Diameter of clearance hole in the fixture pre-positioned installation	$d_f \leq$	[mm]	10,5
Diameter of clearance hole in the fixture in-place installation	$d_f \leq$		14,5
Minimum spacing	$s_{1,\min} = s_{2,\min} \geq$		75 250
Minimum edge distance	$c_{\min} \geq$	[mm]	150 100

Table C 8.9.3: Characteristic resistance F_{Rk} ¹⁾ in [kN] for single anchor

Anchor size SHARK PRO			12
Sand-lime perforated brick KS L, $f_b \geq 6 \text{ N/mm}^2$, Characteristic resistance F_{Rk}	$24^\circ\text{C}^{3)} / 40^\circ\text{C}^{4)}$	[kN]	0.40
Sand-lime perforated brick KS L, $f_b \geq 8 \text{ N/mm}^2$, Characteristic resistance F_{Rk}	$24^\circ\text{C}^{3)} / 40^\circ\text{C}^{4)}$	[kN]	0.60
Sand-lime perforated brick KS L, $f_b \geq 10 \text{ N/mm}^2$, Characteristic resistance F_{Rk}	$24^\circ\text{C}^{3)} / 40^\circ\text{C}^{4)}$	[kN]	0.75
Sand-lime perforated brick KS L, $f_b \geq 12 \text{ N/mm}^2$, Characteristic resistance F_{Rk}	$24^\circ\text{C}^{3)} / 40^\circ\text{C}^{4)}$	[kN]	0.90
Sand-lime perforated brick KS L, $f_b \geq 23 \text{ N/mm}^2$, Characteristic resistance F_{Rk}	$24^\circ\text{C}^{3)} / 40^\circ\text{C}^{4)}$	[kN]	1.5
Partial safety factor	$\gamma_{Mm}^{2)}$	[-]	2.5

Footnotes see Annex C 3

SHARK PRO

Performances

Hollow masonry: Sand-lime perforated brick KS L, 12DF
Brick data, installation parameters, characteristic resistance

Annex C 15

Base material solid masonry, concrete solid block, Vn and Vbn, NF

Table C 8.10.1: Brick data

Description of brick	771-3-004(O)	Vn and Vbn
Type of brick		Concrete solid block
Bulk density	$\rho \geq$ [kg/dm ³]	2.0
Standard, approval		DIN 18153-100:2005-10; EN 771-3:2011
Producer of brick		-
Format (measurement)	[mm]	\geq NF (\geq 240x115x71)
Minimum thickness of member	$h_{\min} =$ [mm]	115

Table C 8.10.2: Installation parameters

Anchor size SHARK PRO		10	12		
Drill hole diameter	$d_0 =$ [mm]	10	12		
Cutting diameter of drill bit	$d_{\text{cut}} \leq$ [mm]	10.45	12.45		
Depth of drill hole to deepest point	$h_1 \geq$ [mm]	$l_s + 5 \text{ mm} - t_{\text{fix}}$			
Drill method	[-]	Hammer drilling			
Overall plastic anchor embedment depth pre-positioned installation	$h_{\text{nom}} =$ [mm]	55	65		
Overall plastic anchor embedment depth in-place installation	$h_{\text{nom}} =$ [mm]	-	57		
Diameter of clearance hole in the fixture pre-positioned installation	$d_f \leq$ [mm]	8.5	10.5		
Diameter of clearance hole in the fixture in-place installation	$d_f \leq$ [mm]	-	14.5		
Minimum edge distance	$c_{\min} \geq$ [mm]	250	100	250	100

Table C 8.10.3: Characteristic resistance $F_{Rk}^{1)}$ in [kN] for single anchor

Anchor size SHARK PRO		10	12		
Concrete solid block Vn and Vbn, $f_b \geq 10 \text{ N/mm}^2$ Characteristic resistance F_{Rk}	$24^\circ\text{C}^{3)} / 40^\circ\text{C}^{4)}$ [kN]	2.0	1.5	1.5	0.90
Concrete solid block Vn und Vbn, $f_b \geq 20 \text{ N/mm}^2$ Characteristic resistance F_{Rk}	$24^\circ\text{C}^{3)} / 40^\circ\text{C}^{4)}$ [kN]	3.0	2.0	2.0	1.5
Concrete solid block Vn und Vbn, $f_b \geq 28 \text{ N/mm}^2$ Characteristic resistance F_{Rk}	$24^\circ\text{C}^{3)} / 40^\circ\text{C}^{4)}$ [kN]	4.0	3.0	3.0	2.0
Concrete solid block Vn und Vbn, $f_b \geq 35,1 \text{ N/mm}^2$ Characteristic resistance F_{Rk}	$24^\circ\text{C}^{3)} / 40^\circ\text{C}^{4)}$ [kN]	4.0	3.0	3.5	2.5
Partial safety factor	$\gamma_{Mm}^{2)}$ [-]	2.5			

Footnotes see Annex C 3

SHARK PRO

Performances

Solid masonry: Concrete solid block Vn and Vbn, NF
Brick data, installation parameters, characteristic resistance

Annex C 16

Base material solid masonry, lightweight concrete solid brick: V and Vbl, 3DF

Table C 8.11.1: Brick data

Description of brick	771-3-017	V and Vbl
Type of brick		Lightweight concrete solid brick
Bulk density	$\rho \geq$ [kg/dm ³]	2.0
Standard, approval		DIN 18152-100:2005-10; EN 771-3:2011
Producer of brick		e.g. Bisophon, Bisotherm GmbH Eisenbahnstraße 12 D-56218 Mühlheim-Kärlich -
Format (measurement)	[mm]	\geq 3DF (\geq 240x175x113)
Minimum thickness of member	$h_{\min} =$ [mm]	175

Table C 8.11.2: Installation parameters

Anchor size SHARK PRO		10	12
Drill hole diameter	$d_o =$ [mm]	10	12
Cutting diameter of drill bit	$d_{\text{cut}} \leq$ [mm]	10.45	12.45
Depth of drill hole to deepest point	$h_1 \geq$ [mm]	$l_s + 5 \text{ mm} - t_{\text{fix}}$	
Drill method	[-]	Hammer drilling	
Overall plastic anchor embedment depth pre-positioned installation	$h_{\text{nom}} =$ [mm]	55	65
Overall plastic anchor embedment depth in-place installation	$h_{\text{nom}} =$ [mm]	-	57
Diameter of clearance hole in the fixture pre-positioned installation	$d_f \leq$ [mm]	8.5	10.5
Diameter of clearance hole in the fixture in-place installation	$d_f \leq$ [mm]	-	14.5
Minimum spacing	$s_{\min} \geq$ [mm]	-	75 250
Minimum edge distance	$c_{\min} \geq$ [mm]	100	180 100

Table C 8.11.3: Characteristic resistance $F_{Rk}^{1)}$ in [kN] for single anchor

Anchor size SHARK PRO		10	12
Lightweight concrete solid brick V and Vbl, $f_b \geq 10 \text{ N/mm}^2$ Characteristic resistance F_{Rk}	$24^\circ\text{C}^{3)} / 40^\circ\text{C}^{4)}$ [kN]	2.5	3.0
Lightweight concrete solid brick V and Vbl, $f_b \geq 20 \text{ N/mm}^2$ Characteristic resistance F_{Rk}	$24^\circ\text{C}^{3)} / 40^\circ\text{C}^{4)}$ [kN]	4.0	4.0
Lightweight concrete solid brick V and Vbl, $f_b \geq 25 \text{ N/mm}^2$ Characteristic resistance F_{Rk}	$24^\circ\text{C}^{3)} / 40^\circ\text{C}^{4)}$ [kN]	5.0	5.0
Partial safety factor	$\gamma_{Mm}^{2)}$ [-]	2.5	

Footnotes see Annex C 3

SHARK PRO

Performances

Solid masonry: Lightweight concrete solid brick V and Vbl, 3DF
Brick data, installation parameters, characteristic resistance

Annex C 17

Base material solid masonry, Lightweight concrete solid brick: V and Vbl, NF

Table C 8.12.1: Brick data

Description of brick		771-3-007	V and Vbl
Type of brick			Lightweight concrete solid brick
Bulk density	$\rho \geq$	[kg/dm ³]	1.2
Standard, approval			DIN V 18152-100:2005-10, EN 771-3:2011
Producer of brick			e.g. BasisBims, Bisotherm GmbH Eisenbahnstraße 12 D-56218 Mühlheim-Kärlich
Format (measurement)		[mm]	\geq NF (\geq 240x115x71)
Minimum thickness of member	$h_{\min} =$	[mm]	115

Table C 8.12.2: Installation parameters

Anchor size SHARK PRO			10
Drill hole diameter	$d_0 =$	[mm]	10
Cutting diameter of drill bit	$d_{\text{cut}} \leq$	[mm]	10.45
Depth of drill hole to deepest point	$h_1 \geq$	[mm]	$l_s + 5 \text{ mm} - t_{\text{fix}}$
Drill method		[-]	Hammer drilling
Overall plastic anchor embedment depth	$h_{\text{nom}} =$	[mm]	55
Diameter of clearance hole in the fixture	$d_f \leq$	[mm]	8.5
Minimum edge distance	$c_{\min} \geq$	[mm]	100

Table C 8.12.3: Characteristic resistance F_{Rk} ¹⁾ in [kN] for single anchor

Anchor size SHARK PRO			10
Lightweight concrete solid brick, V 4 and Vbl 4, $f_b \geq 4 \text{ N/mm}^2$	$24^\circ\text{C}^{3)} / 40^\circ\text{C}^{4)}$	[kN]	0.3
Characteristic resistance F_{Rk}			
Lightweight concrete solid brick, V 6 and Vbl 4, $f_b \geq 6 \text{ N/mm}^2$	$24^\circ\text{C}^{3)} / 40^\circ\text{C}^{4)}$	[kN]	0.5
Characteristic resistance F_{Rk}			
Partial safety factor	$\gamma_{Mm}^{2)}$	[-]	2.5

Footnotes see Annex C 3

SHARK PRO

Performances

Solid masonry: Lightweight concrete solid brick V and Vbl, NF
Brick data, installation parameters, characteristic resistance

Annex C 18

Base material solid masonry, Lightweight concrete solid brick: V and Vbl, 3DF

Table C 8.13.1: Brick data

Description of brick		771-3-016	V and Vbl
Type of brick			Lightweight concrete solid brick
Bulk density	$\rho \geq$	[kg/dm ³]	1.2
Standard, approval			DIN V 18152-100:2005-10, EN 771-3:2011
Producer of brick			e.g. Bisophon, Bisotherm GmbH Eisenbahnstraße 12 D-56218 Mülheim-Kärlich
Format (measurement)		[mm]	$\geq 3DF (\geq 240 \times 175 \times 113)$
Minimum thickness of member	$h_{min} =$	[mm]	175

Table C 8.13.2: Installation parameters

Anchor size SHARK PRO			10	12
Drill hole diameter	$d_0 =$	[mm]	10	12
Cutting diameter of drill bit	$d_{cut} \leq$	[mm]	10.45	12.45
Depth of drill hole to deepest point	$h_1 \geq$	[mm]	$l_s + 5 \text{ mm} - t_{fix}$	
Drill method		[-]	Hammer drilling	
Overall plastic anchor embedment depth pre-positioned installation	$h_{nom} =$	[mm]	55	65
Overall plastic anchor embedment depth in-place installation	$h_{nom} =$	[mm]	-	57
Diameter of clearance hole in the fixture pre-positioned installation	$d_f \leq$	[mm]	8.5	10.5
Diameter of clearance hole in the fixture in-place installation	$d_f \leq$	[mm]	-	14.5
Minimum spacing	$s_{1,min} = s_{2,min} \geq$	[mm]	-	75 250
Minimum edge distance	$c_{min} \geq$	[mm]	60	250 100

Table C 8.13.3: Characteristic resistance $F_{RK}^{1)}$ in [kN] for single anchor

Anchor size SHARK PRO			10	12
Lightweight concrete solid brick, V 2 and Vbl 2, $f_b \geq 2 \text{ N/mm}^2$	$24^\circ\text{C}^{3)} / 40^\circ\text{C}^{4)}$	[kN]	0.4	0.4
Lightweight concrete solid brick, V4 and Vbl 4, $f_b \geq 4 \text{ N/mm}^2$	$24^\circ\text{C}^{3)} / 40^\circ\text{C}^{4)}$	[kN]	0.75	0.9
Lightweight concrete solid brick, V6 and Vbl 6, $f_b \geq 6,8 \text{ N/mm}^2$	$24^\circ\text{C}^{3)} / 40^\circ\text{C}^{4)}$	[kN]	1.2	1.5
Partial safety factor	$\gamma_{Mm}^{2)}$	[-]	2.5	

Footnotes see Annex C 3

SHARK PRO

Performances

Solid masonry: Lightweight concrete solid brick V and Vbl, 3DF
Brick data, installation parameters, characteristic resistance

Annex C 19

Base material solid masonry: Autoclaved Aerated Concrete AAC

Table C 8.14.1: Brick data

Description of brick		AAC
Type of brick		Autoclaved Aerated Concrete
Bulk density	$\rho \geq$ [kg/dm ³]	0.3
Standard, approval		EN 771-4:2011
Measurement	[mm]	$\geq 499 \times 175 \times 249$
Minimum thickness of member	$h_{\min} =$ [mm]	175

Table C 8.14.2: Installation parameters

Anchor size SHARK PRO		10	12
Drill hole diameter	$d_0 =$ [mm]	10	12
Cutting diameter of drill bit	$d_{\text{cut}} \leq$ [mm]	10.45	12.45
Depth of drill hole to deepest point	$h_1 \geq$ [mm]	$l_s + 5 \text{ mm} - t_{\text{fix}}$	
Drill method	[-]	Hammer drilling	
Overall plastic anchor embedment depth pre-positioned installation	$h_{\text{nom}} =$ [mm]	55	65
Overall plastic anchor embedment depth in-place installation	$h_{\text{nom}} =$ [mm]	-	57
Diameter of clearance hole in the fixture pre-positioned installation	$d_f \leq$ [mm]	8.5	10.5
Diameter of clearance hole in the fixture in-place installation	$d_f \leq$ [mm]	-	14.5

Table C 8.14.3: Characteristic resistance F_{Rk} ¹⁾ in [kN] for single anchor

Anchor size SHARK PRO		10	12
Autoclaved Aerated Concrete AAC $f_b \geq 4$ N/mm²	24°C ³⁾ / 40°C ⁴⁾		
Characteristic resistance F_{Rk}	[kN]	1.2	1.2
Autoclaved Aerated Concrete AAC $f_b \geq 5$ N/mm²	24°C ³⁾ / 40°C ⁴⁾		
Characteristic resistance F_{Rk}	[kN]	1.5	1.5
Autoclaved Aerated Concrete AAC $f_b \geq 6$ N/mm²	24°C ³⁾ / 40°C ⁴⁾		
Characteristic resistance F_{Rk}	[kN]	2.0	2.0
Autoclaved Aerated Concrete AAC $f_b \geq 7$ N/mm²	24°C ³⁾ / 40°C ⁴⁾		
Characteristic resistance F_{Rk}	[kN]	2.0	2.0
Partial safety factor	$\gamma_{\text{MAAC}}^{2)}$ [-]	2.0	

Footnotes see Annex C 3

SHARK PRO

Performances

Solid masonry: Autoclaved aerated concrete
Brick data, installation parameters, characteristic resistance

Annex C 20

Base material precast prestressed hollow core elements

Table C 8.15.1: Brick data

Description		Precast prestressed hollow core elements
Base material		Precast prestressed hollow core elements ≥ C30/37
Standard, approval		DIN EN 1168: 2011-12

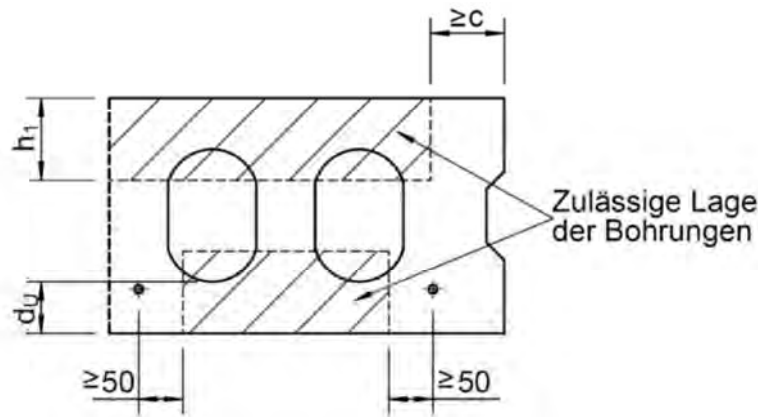

Table C 8.15.2: Installation parameters

Anchor size SHARK PRO			10
Member thickness	$d_u \geq$	[mm]	25
Drill hole diameter	d_0	[mm]	10
Cutting diameter of drill bit	$d_{cut} \leq$	[mm]	10.45
Depth of drill hole to deepest point	$h_1 \geq$	[mm]	$l_s + 5 \text{ mm} - t_{fix}$
Drill method		[-]	Hammer drilling
Overall plastic anchor embedment depth	$h_{nom} =$	[mm]	55
Diameter of clearance hole in the fixture	$d_f \leq$	[mm]	8.5
edge distance	$c \geq$	[mm]	80

Table C 8.15.3: Characteristic resistance $F_{Rk}^{1)}$ in [kN] for single anchor

Anchor size SHARK PRO			10
Member thickness	$d_u \geq$	[mm]	25
Precast prestressed hollow core elements ≥ C30/37, Characteristic resistance F_{Rk}	$24^\circ\text{C}^{3)} / 40^\circ\text{C}^{4)}$	[kN]	0.75
Partial safety factor	$\gamma_{Mm}^{2)}$	[-]	1.8

Footnotes see Annex C 3

SHARK PRO

Performances

Precast prestressed hollow core elements
Brick data, installation parameters, characteristic resistance

Annex C 21